

GT-7508

Potential Distributor, ID Type, 8channels, 0VDC, 10 RTB

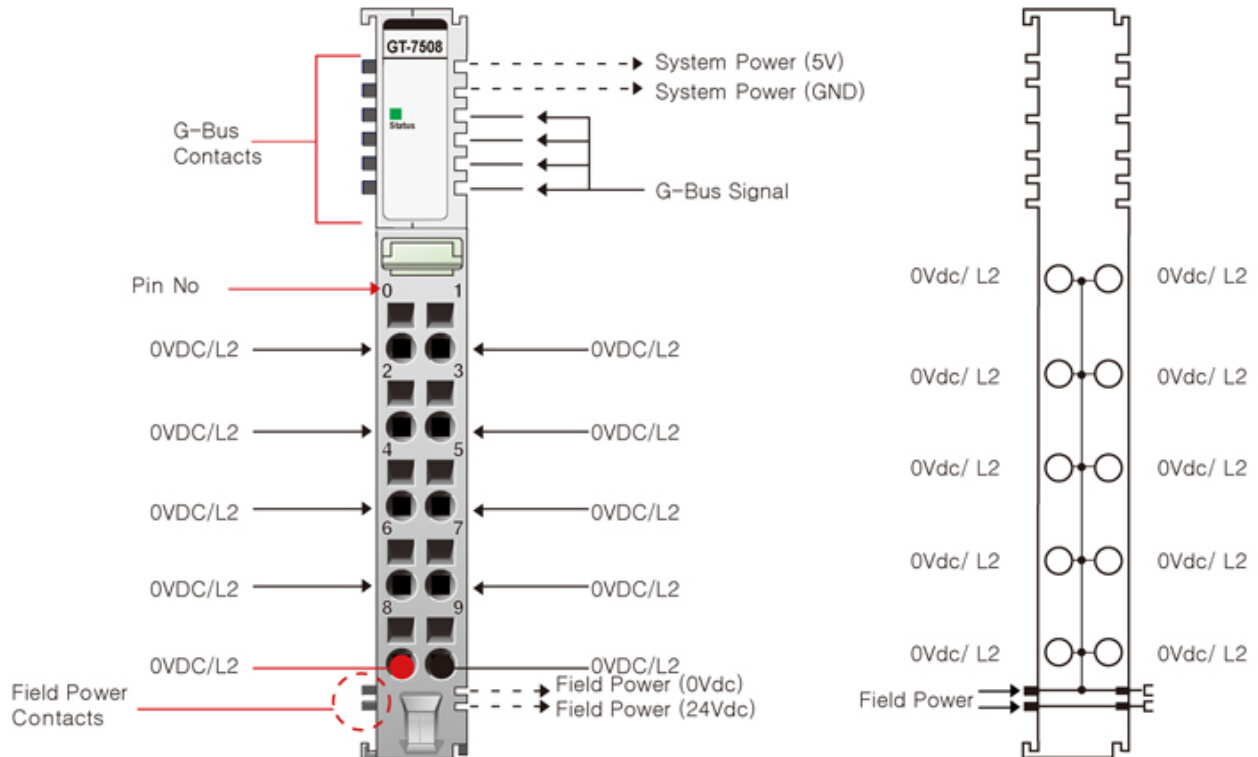

GT-7508 Specification

Field Power Voltage	Norminal 24Vdc
Field Power Contacts Current	Max. 10A
Indicator	Operating Temperature
	-40°C~50°C: Max. 10A
	50°C~70°C: Max. 7A
Indicator	1 Green LEDs
	1 Green Internal Bus State

General specification

System Power Dissipation	Max. 30mA @ 5Vdc
Wiring	I/O Cable Max. 2.0mm ² (AWG 14)
Weight	70g Max.
Module Size	12mm x 99mm x 70mm

Pin No.	Description
0	0VDC/L2
1	0VDC/L2
2	0VDC/L2
3	0VDC/L2
4	0VDC/L2
5	0VDC/L2
6	0VDC/L2
7	0VDC/L2
8	24VDC/L1
9	24VDC/L1