

GT-5221

1 Channel, RS-422 Serial Interface, 10 RTB

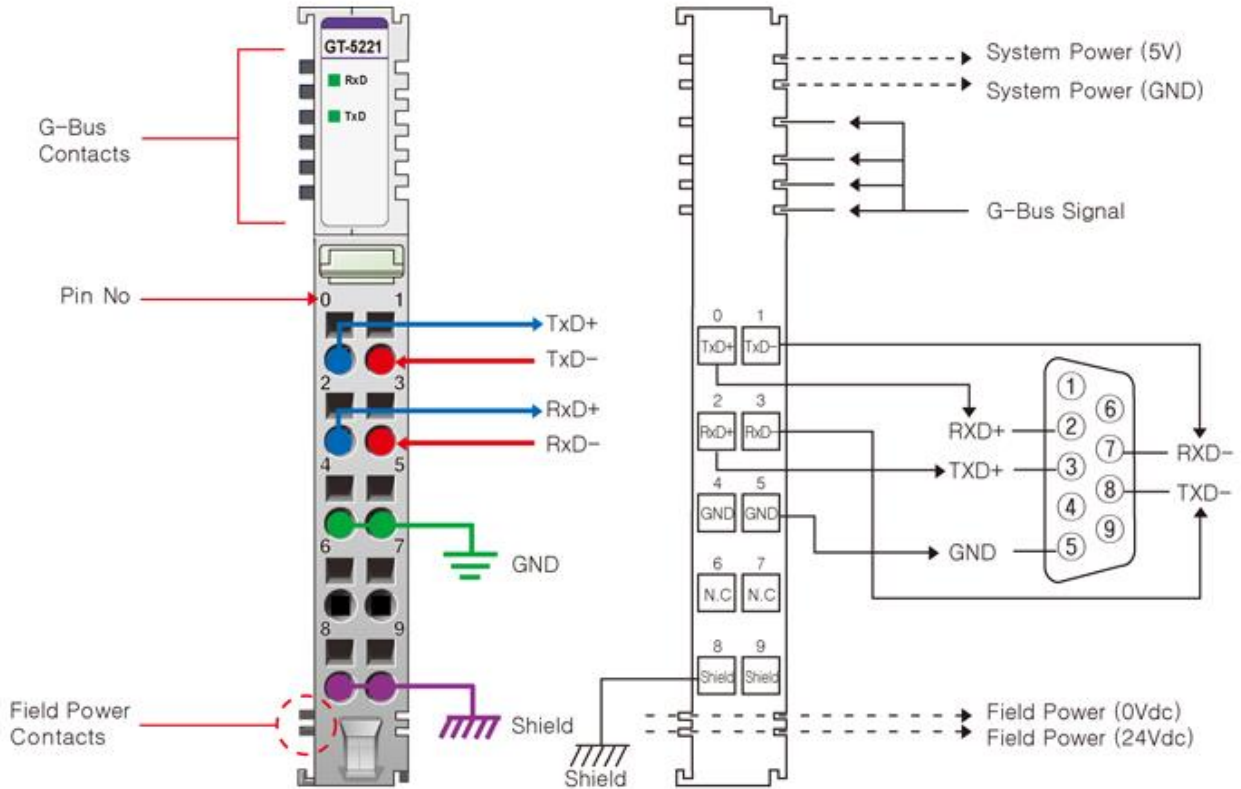

GT-5221 Serial Specification

Transfer Channels	TxD, RxD, Full Duplex
Transfer Rate	1200bps~115200bps
Data Bit	8bit
Parity Bit	None, Odd, Even(*Default: None)
Stop Bit	1bit, 2bit (*Default: 1bit)
Flow Control	-
Bit Distortion	-
Connection	10 RTB
Cable Type	Shield Cable Recommended
Cable Length	1km twisted pair
Low Signal Voltage	-
High Signal Voltage	-

Data Buffer	IO User data 14 bytes IO size changed Max. 63 bytes Control/Status 1 byte, Rx/Tx Length 1 byte
RXD Buffer	1024bytes
TXD Buffer	1024bytes
Line Impedance	120Ω
Input Image Size	16 bytes (*Default) @ Max. 63 bytes
Output Image Size	16 bytes (*Default) @ Max. 63 bytes

General specification

Power dissipation	Max. 85mA @ 5.0Vdc
Isolation	I/O to Logic: Isolation Logic to Field power: Isolation (Not used) Logic to System Power: Non-isolation

Relative Humidity	5% ~ 90% Non-condensing
-------------------	----------------------------

Field Power	Not used (Field Power is bypass)
Wiring	I/O Cable Max. 2.0mm ² (AWG 14)
Weight	57g
Module Size	12mm x 99mm x 70mm

Pin No.	Description
0	TxD
1	RxD
2	RTS
3	CTS
4	Common (GND)
5	Common (GND)
6	N.C
7	N.C
8	Shield
9	Shield