

FBs-2ARTD4

2 Channel A/D Input Module / 4 Channel RTD Temperature Input Module



Introduction

FBs-2ARTD4 is one of the Analog and Temperature mixed input modules of FATEK FBs series PLC.

For analog input it provides 2 channels A/D input with 12 or 14 bit effective resolution. Base on the different jumper settings it can measure the varieties of current or voltage signal. The reading value is represented by a 14 bit value no matter the effective resolution is set to 12 or 14 bit The output code also can be configured as unipolar or bipolar which makes the relation of input code and real input signal more intuitive.. In order to filter out the field noise imposed on the signal, it also provides the average of sample input function.

For temperature measure It provides 4 channels of RTD temperature measurement input with 0.1 °C or 1 °C resolution. The scan rate for 0.1 °C resolution is 2 seconds, while the scan rate for 1 °C resolution is 1 second. This module provides three-wire connection for RTD temperature sensor, thus can automatically compensate the resistance introduced by the wiring. All the optional features of this module are software configurable, there are no hardware jumpers or switches for user to setup.

Dimensions

Analog Input Specification

- Channels** – 2CH
- Resolution** – 14 or 12 bits
- Signal Resolution** – 0.3mV(Voltage), 0.61uA(Current)
- I/O Points Occupied** – 2 IR(Input Register)
- Conversion Time** – Updated each scan
- Accuracy** – ±1 %
- Max. Absolute Input Rating** – ±15V,30mA
- Software Filter** – Moving average
- Average Samples** – 1~16 configurable
- Input Impedance** – 63.2kΩ(Voltage) 、 250Ω(Current)
- Measurement Range** – -10~+10V, -5~+5V, 0~10V, 0~5V, -20~+20mA, -10~+10mA, 0~20mA, 0~10mA

RTD Specification

- Channels** – 4CH
- Resolution** – 0.1°C or 1°C
- I/O Points Occupied** – 2 IR(Input Register) 8 DO(Discrete Output)
- Conversion Time** – 1 or 2 Sec.
- Accuracy** – ±1%
- Sensor Type** – Pt100,Pt1000(DIN or JIS)
- Software Filter** – Moving average
- Average Samples** – 1~8 configurable
- Measurement Range** – Pt100: -200~850°C Pt1000: -200~600°C

Comm. Specification

- Isolation** – Transformer(Power) and photo-coupler(Signal)
- Indicator(s)** – 5V PWR LED
- Supply Power** – 24V-15%/+20%,2VA
- Internal Power Consumption** – 5V, 100mA
- Operating Temperature** – 0 ~ 60 °C
- Storage Temperature** – -20~ 80 °C
- Dimensions** – 40(W) X 90(H) X 80(D)mm

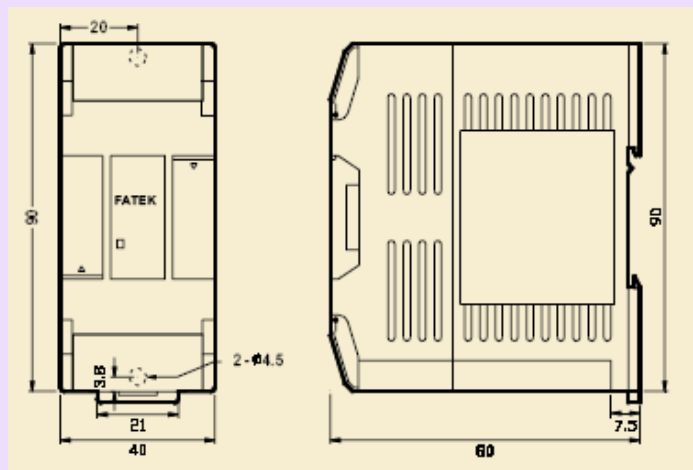

FBs-2ARTD4

2 Channel A/D Input Module / 4 Channel RTD Temperature Input Module

Wiring Diagram

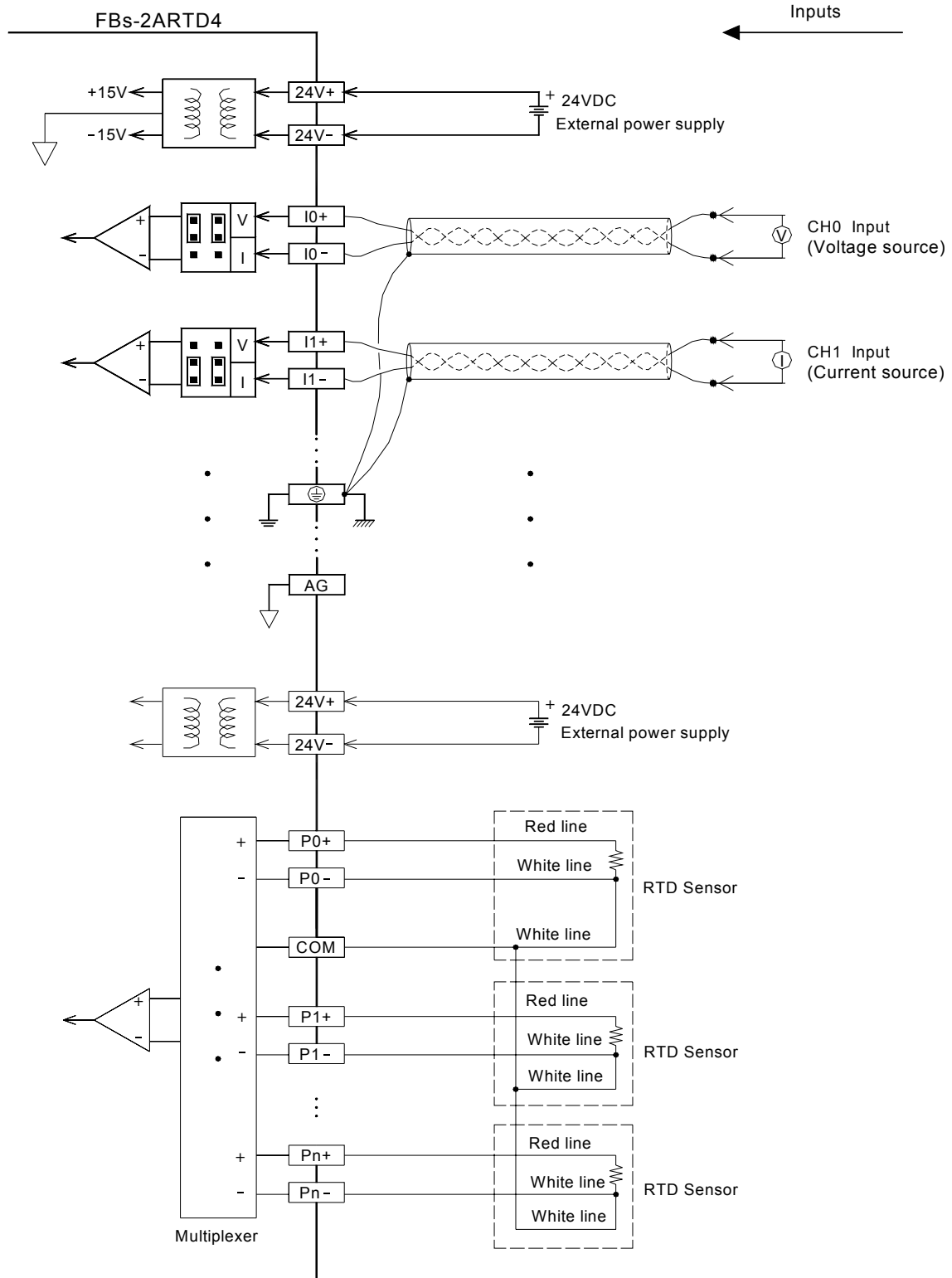





FBs-2ARTD4

2 Channel A/D Input Module / 4 Channel RTD Temperature Input Module

A/D Jumper Setup

Input Code Format Selection

There are two input data formats can be selected which are bipolar and unipolar. The range of input value is 0~16383 for unipolar format while bipolar is -8192~8191. The two extreme values of each range corresponding to the minimal and maximal input signal. For example, if chose the -10V~+10V type signal, for 10V input signal the input value is 16383 for unipolar format while the bipolar format is 8191. Normally the input code format setting is consistent with input signal type (bipolar coded for bipolar input signal, unipolar coded for unipolar input signal). Only when use the FUN32 for offset conversion should set the bipolar code for unipolar input signal (Please refer the FUN32 description). The code format of all input channels are set by the same JP1 jumper. The location and the setting of jumper of JP1 are shown at below

Corresponding Input	JP1 Setup	Code Format
-10V ~ 10V(-20mA ~ 20mA)	 JP1 U B	-8192 ~ 8191
-5V ~ 5V(-20mA ~ 20mA)		0 ~ 16383
0V ~ 10V(0mA ~ 20mA)	 JP1 U B	-8192 ~ 8191
0V ~ 5V(0mA ~ 10mA)		0 ~ 16383

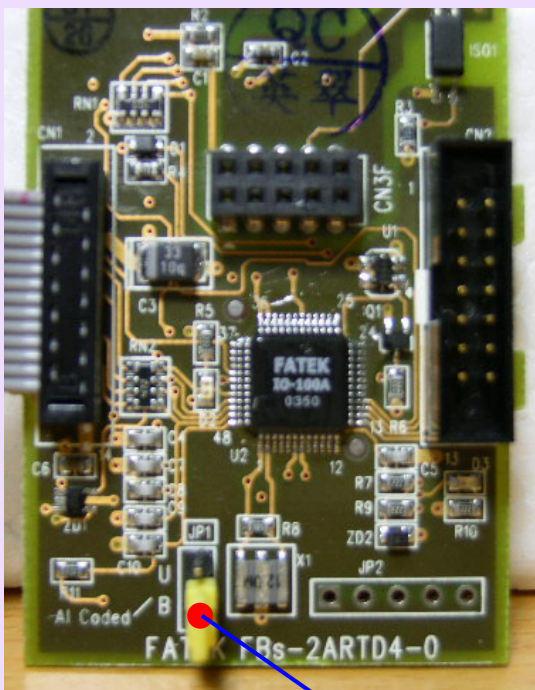



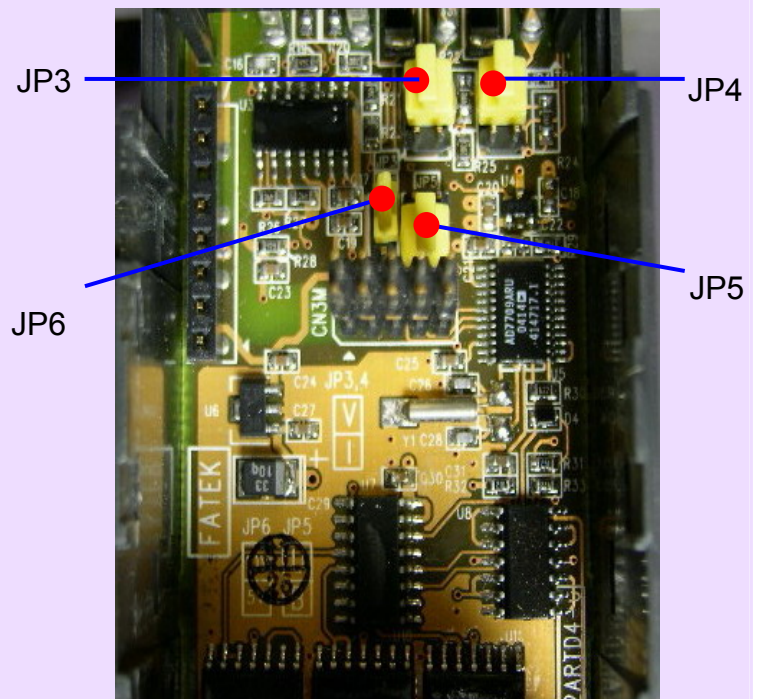

JP1

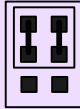
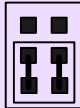

Voltage/Current input signal type setting

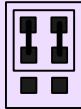
Signal Type	JP3 ~ JP4
Voltage	
Current	

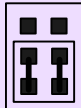
A/D Signal Type selection

Signal Type	Polarity Setting (JP5)	Range Setting (JP6)
0~10V or 0~20mA		
0~5V or 0~10mA		
-10~+10V or -20~+20mA		
-5~+5V or -10mA~+10mA		

The default factory settings of 2ARTD4 analogue input/output module are

Input code format – Bipolar(-8192~+8191)

Input signal type and range – Bipolar(-10V ~ +10V)

Output code format – Bipolar(-8192~+8191)

Output signal type and range – Bipolar(-10V ~ +10V)

For those applications that require the setting differ than the above default setting should make some modifications of jumper position according to above tables.

While application, besides the setting of jumper should be conducted, the AI module configuration of Winproladder also need to be performed.