

# PROFINET Network Adapter GL-9087

## User Manual



**CREVIS Co., Ltd.**

---

DOCUMENT CHANGE SUMMARY				
REV	PAGE	REMARKS	DATE	EDITOR
1.00	New Document		2020/08/26	JY HYUN
1.01	12	IP Setting Information corrected -. IP Address Setup by Master Device Software	2020/10/28	JY HYUN

## CONTENTS

<b>1. Important Notes .....</b>	<b>5</b>
<b>1.1. Safety Instruction.....</b>	<b>6</b>
<b>1.1.1. Symbols.....</b>	<b>6</b>
<b>1.1.2. Safety Notes .....</b>	<b>6</b>
<b>1.1.3. Certification.....</b>	<b>6</b>
<b>2. Environment Specification .....</b>	<b>7</b>
<b>3. GL-9087(Modbus TCP/UDP Network Adapter .....</b>	<b>8</b>
<b>3.1. GL-9087 Specification .....</b>	<b>8</b>
<b>3.2. GL-9087 Wiring Diagram .....</b>	<b>9</b>
<b>3.3. GL-9087 LED Indicator .....</b>	<b>10</b>
<b>3.3.1. LED Indicator.....</b>	<b>10</b>
<b>3.3.2. MOD(Module Status LED).....</b>	<b>10</b>
<b>3.3.3. NET(Network Status LED).....</b>	<b>10</b>
<b>3.3.4. ERROR(Error Status LED) .....</b>	<b>11</b>
<b>3.3.5. IOS LED(Expansion Module Status LED) .....</b>	<b>11</b>
<b>3.4. GL-9087 Electrical Interface.....</b>	<b>12</b>
<b>3.4.1. RJ45 Socket.....</b>	<b>12</b>
<b>3.4.2. Dip Switch.....</b>	<b>12</b>
<b>4. I/O Process Image Map.....</b>	<b>13</b>
<b>4.1. Mapping Data into Image Table .....</b>	<b>14</b>
<b>4.1.1. Discrete Input Module.....</b>	<b>14</b>
<b>4.1.2. Discrete Output Module .....</b>	<b>15</b>
<b>4.1.3. Analog Input Module .....</b>	<b>16</b>
<b>4.1.3. Analog Output Module .....</b>	<b>17</b>
<b>4.2. Example of Input Process Image(Input Register) Map.....</b>	<b>18</b>
<b>4.3. Example of Output Process Image(Output Register) Map .....</b>	<b>19</b>
<b>5. Parameter .....</b>	<b>20</b>
<b>5.1. GL-9087 Parameter .....</b>	<b>20</b>
<b>5.2. GL-9087 PROFINET IO Characteristics .....</b>	<b>20</b>
<b>5.2.1. Device Identity.....</b>	<b>20</b>
<b>5.2.2. Device Access Point.....</b>	<b>21</b>
<b>5.2.3. Sub-slot of GL-9087 .....</b>	<b>22</b>

---

<b>6. Dimension</b> .....	<b>23</b>
<b>6.1. GL-9087</b> .....	<b>23</b>
<b>7. Mechanical Set Up</b> .....	<b>24</b>
<b>7.1. Total Expansion</b> .....	<b>24</b>
<b>7.2. Plugging and Removal of the Components</b> .....	<b>24</b>
<b>7.3. Internal FnBus/Field Power Contacts</b> .....	<b>25</b>
<b>8. Trouble Shooting</b> .....	<b>26</b>
<b>8.1. How to diagnose by LED indicator</b> .....	<b>26</b>
<b>A. APPENDIX A</b> .....	<b>28</b>
<b>A.1. Product List</b> .....	<b>28</b>
<b>A.2. Glossary</b> .....	<b>30</b>

## 1. Important Notes

Solid state equipment has operational characteristics differing from those of electromechanical equipment. Safety Guidelines for the Application, Installation and Maintenance of Solid State Controls describes some important differences between solid state equipment and hard-wired electromechanical devices.

Because of this difference, and also because of the wide variety of uses for solid state equipment, all persons responsible for applying this equipment must satisfy themselves that each intended application of this equipment is acceptable.

In no event will CREVIS be responsible or liable for indirect or consequential damages resulting from the use or application of this equipment.

The examples and diagrams in this manual are included solely for illustrative purposes. Because of the many variables and requirements associated with any particular installation, CREVIS cannot assume responsibility or liability for actual use based on the examples and diagrams.



### Warning!

- ✓ **If you don't follow the directions, it could cause a personal injury, damage to the equipment or explosion**
- Do not assemble the products and wire with power applied to the system. Else it may cause an electric arc, which can result into unexpected and potentially dangerous action by field devices. Arching is explosion risk in hazardous locations. Be sure that the area is non-hazardous or remove system power appropriately before assembling or wiring the modules.
- Do not touch any terminal blocks or IO modules when system is running. Else it may cause the unit to an electric shock or malfunction.
- Keep away from the strange metallic materials not related to the unit and wiring works should be controlled by the electric expert engineer. Else it may cause the unit to a fire, electric shock or malfunction.

### Caution!

- ✓ **If you disobey the instructions, there may be possibility of personal injury, damage to equipment or explosion. Please follow below Instructions.**
- Check the rated voltage and terminal array before wiring. Avoid the circumstances over 55°C of temperature. Avoid placing it directly in the sunlight.
- Avoid the place under circumstances over 85% of humidity.
- Do not place Modules near by the inflammable material. Else it may cause a fire.
- Do not permit any vibration approaching it directly.
- Go through module specification carefully, ensure inputs, output connections are made with the specifications. Use standard cables for wiring.
- Use Product under pollution degree 2 environment.

### 1.1.1. Symbols

<p><b>DANGER</b></p> 	<p>Identifies information about practices or circumstances that can cause an explosion in a hazardous environment, which may lead to personal injury or death property damage or economic loss.</p>
<p><b>IMPORTANT</b></p>	<p>Identifies information that is critical for successful application and understanding of the product.</p>
<p><b>ATTENTION</b></p> 	<p>Identifies information about practices or circumstances that can lead to personal injury, property damage, or economic loss. Attentions help you to identify a hazard, avoid a hazard, and recognize the consequences.</p>

### 1.1.2. Safety Notes

<p><b>DANGER</b></p> 	<p>The modules are equipped with electronic components that may be destroyed by electrostatic discharge. When handling the modules, ensure that the environment (persons, workplace and packing) is well grounded. Avoid touching conductive components, e.g. G-BUS Pin.</p>
--	--

### 1.1.3. Certification

c-UL-us UL Listed Industrial Control Equipment, certified for U.S. and Canada  
See UL File E235505

FCC, Reach, RoHS- II, China RoHS

CE Certificate

EN 61000-6-2; Industrial Immunity  
EN 61000-6-4; Industrial Emissions

## 2. Environment Specification

Environment Specification	
Operating Temperature	-40°C ~ 60°C : 1.0A full load is allowed
UL Temperature	-20°C ~60°C
Storage Temperature	-40°C ~85°C
Relative Humidity	5% ~ 90% non-condensing
Mounting	DIN rail
General Specification	
Shock Operating	IEC 60068-2-27
Vibration resistance	Based on IEC 60068-2-6 DNVGL-CD-0039 : Vibration Class B, 4g
Industrial Emissions	EN 61000-6-4/ALL : 2011
Industrial Immunity	EN 61000-6-2 : 2005
Installation Position	Vertical and horizontal installation is available.
Product Certifications	CE, UL, FCC

### 3. GL-9087 (MODBUS TCP/UDP Network Adapter)

#### 3.1. GL-9087 Specification

Items	Specification
<b>Communication Specification</b>	
Adapter Type	Slave node (Profinet)
Protocol	Profinet
Max. Expansion Module	10 Slots
Max. Data Size	Max. Input 128bytes / Output 128bytes
Max. Length Bus Line	Up to 100m from Ethernet Hub/Switch with twisted CATS UTP/STP
Max. Nodes	Limited by Profinet Specification
BuadRate	100Mbps, Auto-negotiation, Full duplex
Interface Connector	RJ-45 socket * 2pcs
IP-Address Setup	Via Master Device Software
IAP Mode	When DIP Switch 1 to 8 setting is 254 or 255 (Using only Internet Explorer / recommended version 11)
Indicator	4 LEDs 1 Green/Red, Module Status (MOD) 1 Green/Red, Network Status (NET) 1 Green/Red, Network Error (ERROR) 1 Green/Red, Expansion I/O Module Status (IOS) 2 LEDs (each RJ45 Connector) 1 Yellow, Link/Active 1 Green, Not used
Module Location	Starter module left side of G-Series System
<b>General Specification</b>	
UL System Power	Supply voltage : 24Vdc nominal, Class 2
System Power	Supply voltage : 24Vdc nominal Supply voltage range : 15~28.8Vdc Protection : Reverse polarity protection
Power Dissipation	55mA typical @24Vdc
Current for I/O Module	1.0A @5Vdc
Isolation	System power to internal logic : Non-Isolation System power I/O driver : Isolation
UL Field Power	Supply voltage : 24Vdc nominal, Class 2
Field Power	Supply voltage : 24Vdc typical (Max.28.8Vdc) * Field Power range is defferent depending on IO Module series. Refer to IO Module's specification.
Max. Current Field Power Contact	DC 8A Max.
Wiring	I/O Cable Max. 2.0mm <sup>2</sup> (AWG 14)
Torque	0.8Nm(7 lb-in)
Weight	76g
Module Size	22mm x 109mm x 70mm
<b>Environment Condition</b>	<b>Refer to 'Environment Specification'</b>



### 3.2. GL-9087 Wiring Diagram

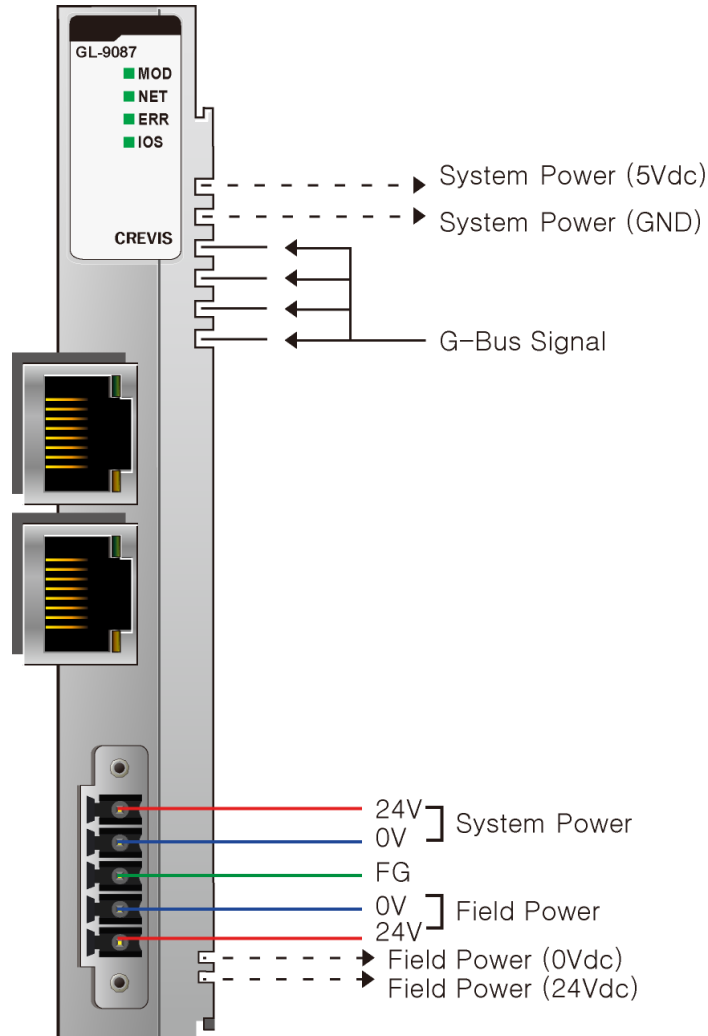

Pin No.	Signal Description
1	System Power, 24V
2	System Power, Ground
3	Frame Ground
4	Field Power, Ground
5	Field Power, 24V

### 3.3. GL-9087 LED Indicator

#### 3.3.1. LED Indicator

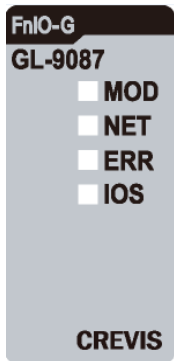

LED	LED Function / Description	LED Color
MOD	Module Status	Green/Red
NET	Current Communication Status	Green/Red
ERR	Error Status (Profinet)	Red
IOS	Extension Module Status	Green/Red

#### 3.3.2. MOD(Module Status LED)

Status	LED	To indicate
Not Powered	OFF	No power is supplied to the unit.
Device Operational	Green	The unit is operating in normal condition.
Unrecoverable Fault	Red	The device has an unrecoverable fault. - Memory error or CPU watchdog error.

#### 3.3.3. NET(Network Status LED)

State	LED	To indicate
Not Powered	OFF	No power is supplied to the unit.
Communication	Green	Normal communication.
Communication Ready	Flashing Green	Communication identification.
Invalid Configuration	Flashing Red	DCP Communication error(Invalid Configuration).

### 3.3.4. ERR (Error Status LED)

Status	LED	To indicate :
No Error	OFF	No Error.
Connection error	Red	Communication connection error.

### 3.3.5. IOS LED (Expansion Module Status LED)

State	LED	To indicate
Not Powered	OFF	Device may not be powered.
No Expansion Module	Flashing Red	Adapter has no expansion module
Internal Bus Connection, Run Exchanging I/O	Green	Exchanging I/O data.
Expansion Configuration Failed	Red	One or more expansion module occurred in fault state. <ul style="list-style-type: none"> <li>- Detected invalid expansion module ID.</li> <li>- Overflowed Input/Output Size</li> <li>- Too many expansion moduel</li> <li>- Initialization failure</li> <li>- Communication failure</li> <li>- Changed expansion module configuration</li> <li>- Mismatch vendor code between adapter and expansion module</li> </ul>

## 3.4. GL-9087 Electrical Interface

### 3.4.1. RJ45 Socket

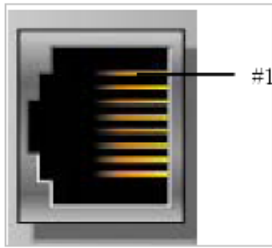

Shielded RJ-45 Socket

RJ-45	Singal Name	Description
1	TD+	Transmit +
2	TD-	Transmit -
3	RD+	Receive +
4	-	
5	-	
6	RD-	Receive -
7	-	
8	-	
Case	Shield	Shield RJ-45 Socket

### 3.4.2. Dip Switch



DIP Pole#	Description	
1	IP DIP bit#0	Device Name (GN9587-XX) -XX must a value between 1~99
2	IP DIP bit#1	
3	IP DIP bit#2	
4	IP DIP bit#3	
5	IP DIP bit#4	
6	IP DIP bit#5	
7	IP DIP bit#6	
8	Reserve	
9	IP-Address ( Control by Master )	
10	Node ID : Flash Memory Value	

- **When the dip switch is not set to non-zero (1~99) :**

If the decimal value of the dip switch is not zero (0), the name of device will be fixed as "GL9087-xx" (xx: 1~99). You must put the fixed device name.

- **When the dip switch "10 pole" is set to switch ON :**

GL-9087 Devices on a PROFINET subnet must have unique names. The device names must satisfy DNS naming conventions. This means that the following rules must be observed:

- Names are limited to a total of 127 characters (letters, numbers, dashes or dots)
- Any component part (that is, a character string between two dots) of the device name may only be up to 10 characters long.
- Names cannot contain any special characters such as umlauts, parentheses, underscores, forward or backward slashes, empty spaces, etc. The dash is the only special character allowed.
- Names must not begin or end with the "-" or "." characters.
- Names must not have the format n.n.n.n (where n = 0...999).
- The device name must not start with numbers.

Device names are assigned to PROFINET IO device when the device is being set up and placed in operation for the first time ("commissioned").

The default name is "GL9087-address".

### 4. I/O Process Image Map

An expansion module may have 3 types of data as I/O data, configuration parameter and memory register. The data exchange between network adapter and expansion modules is done via an I/O process image data by G-Series Internal Bus protocol. The following figure shows the data flow of process image between network adapter and expansion modules.

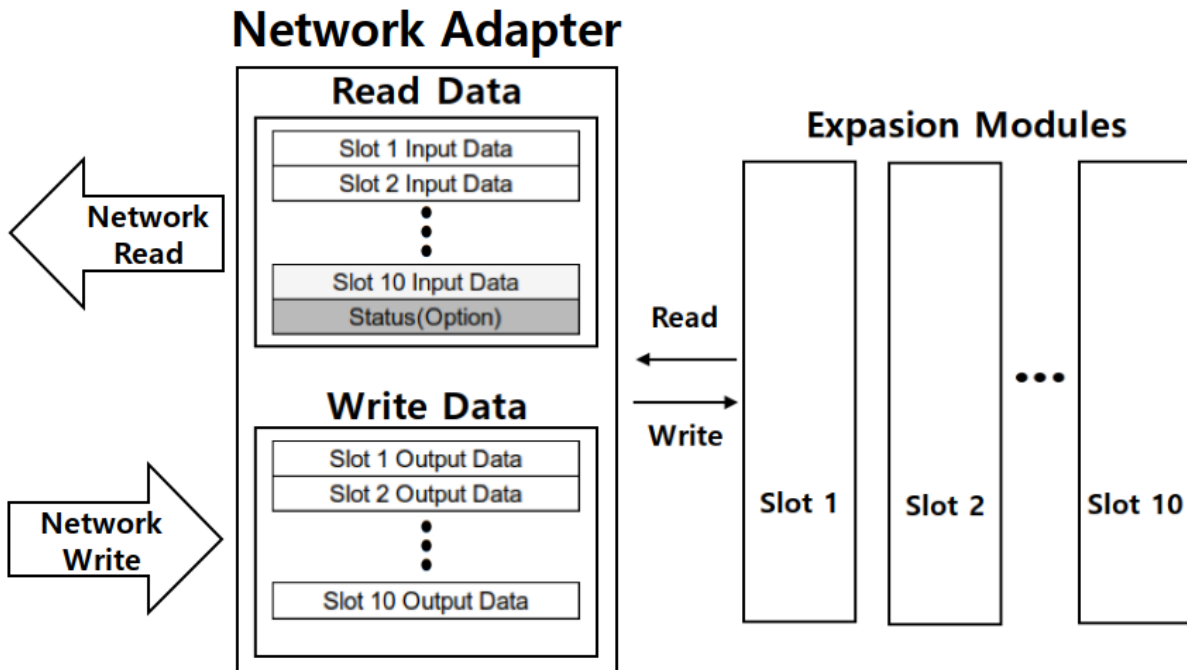

## 4.1. Mapping Data into Image Table

### 4.1.1. Discrete Input Module

- . 4 Point Input Module

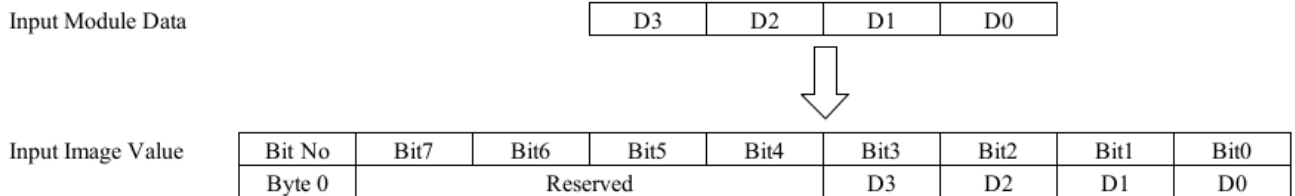

- . 8 Point Input Module

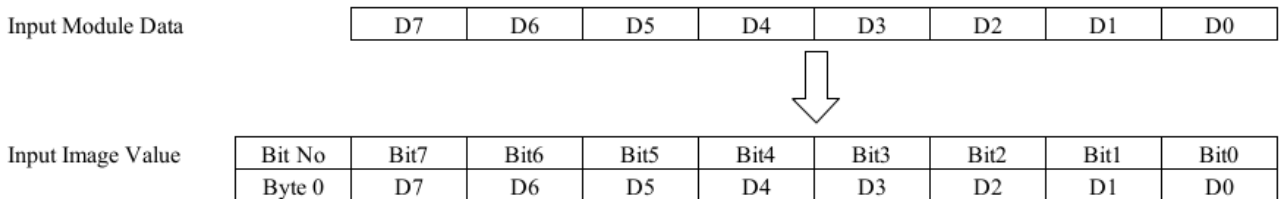

- . 16 Point Input Module

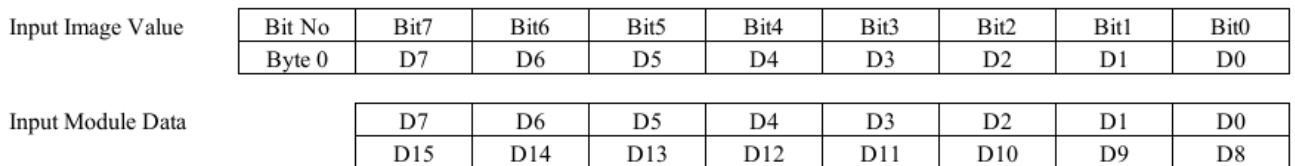

- . 32 Point Input Module

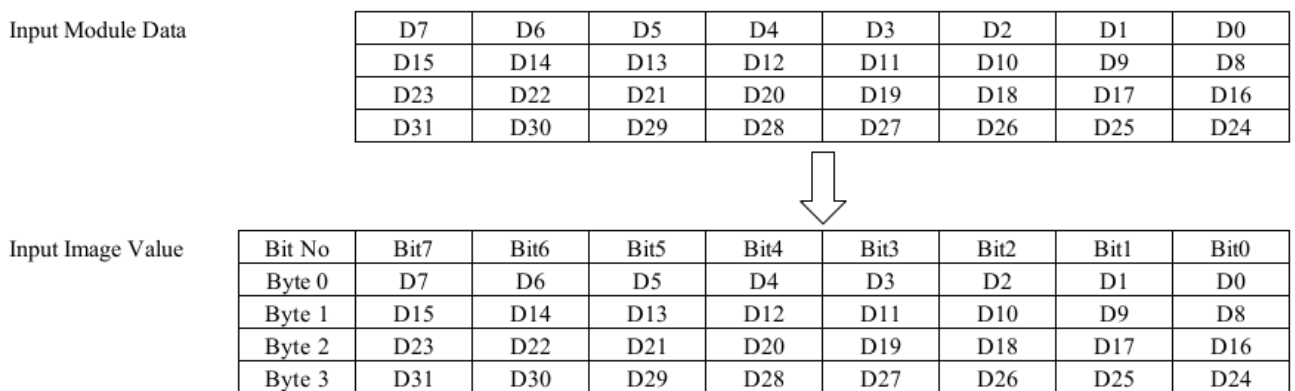

## 4.1.2. Discrete Output Module

### - . 4 Point Output Module

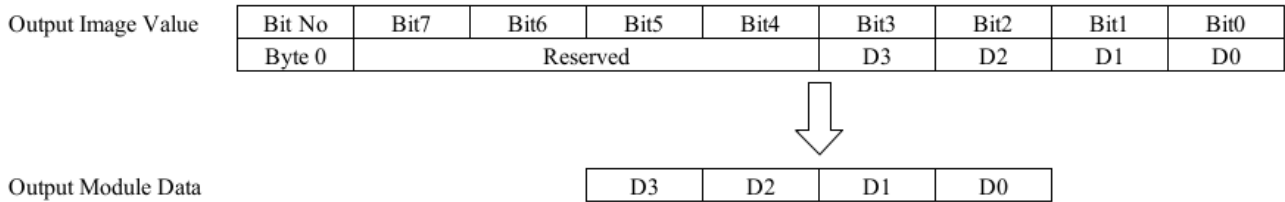

### - . 8 Point Output Module

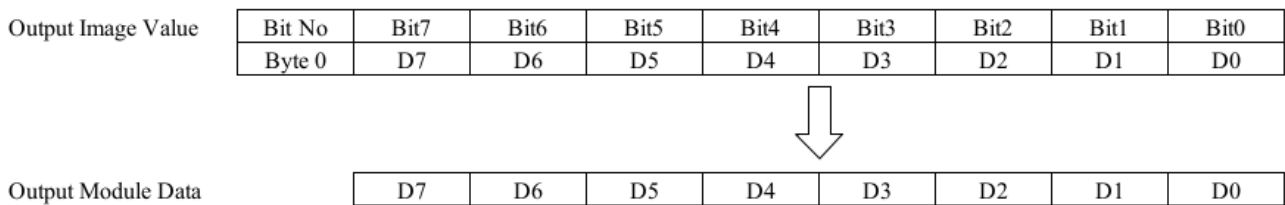

### - . 16 Point Output Module

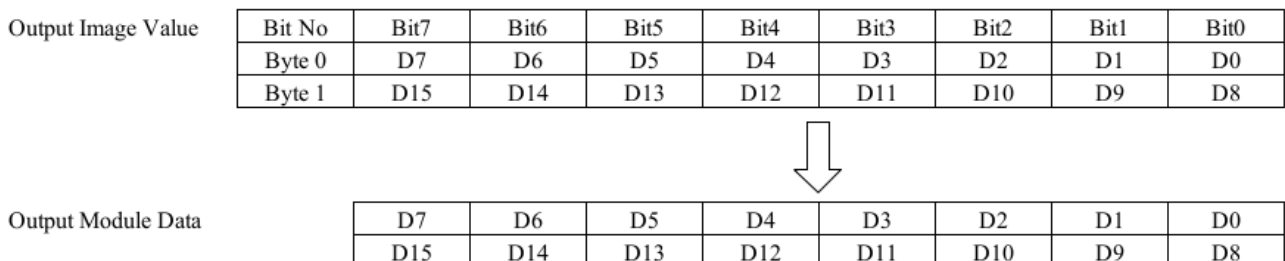

### - . 32 Point Output Module

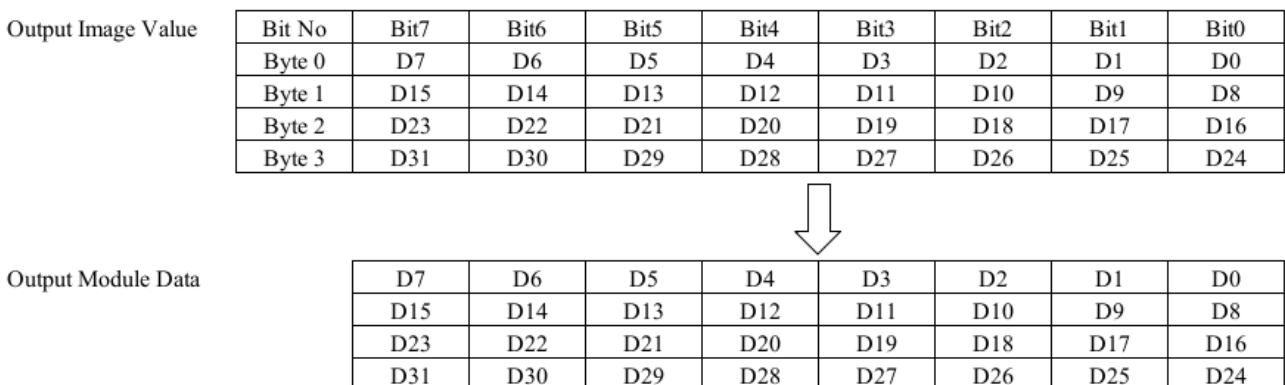

### 4.1.3. Analog Input Module

#### - . 4 Channel Analog Input Module

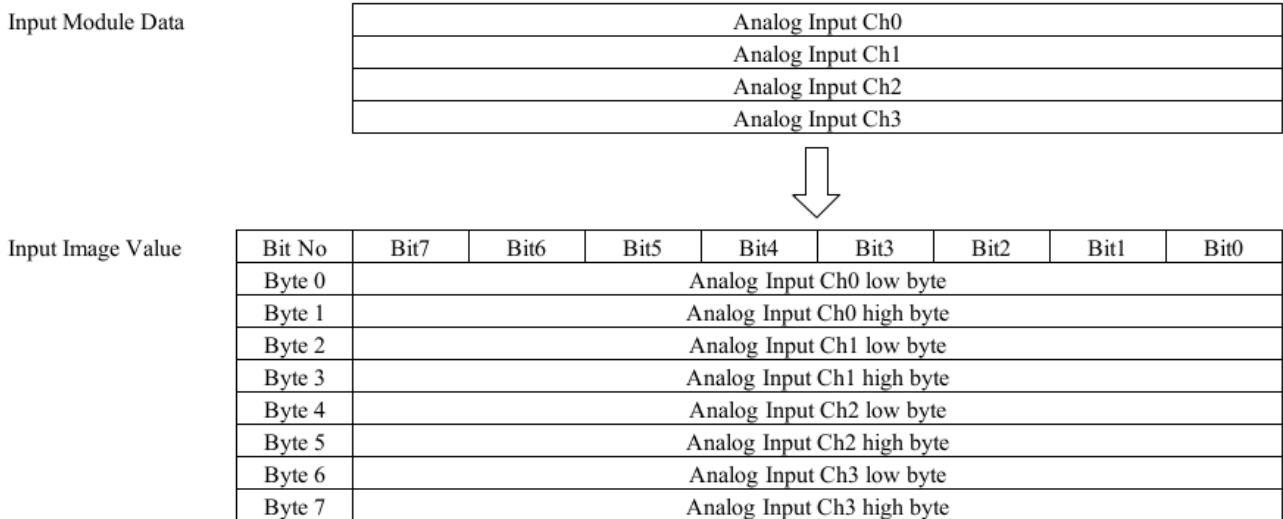

#### - . 8 Channel Analog Input Module

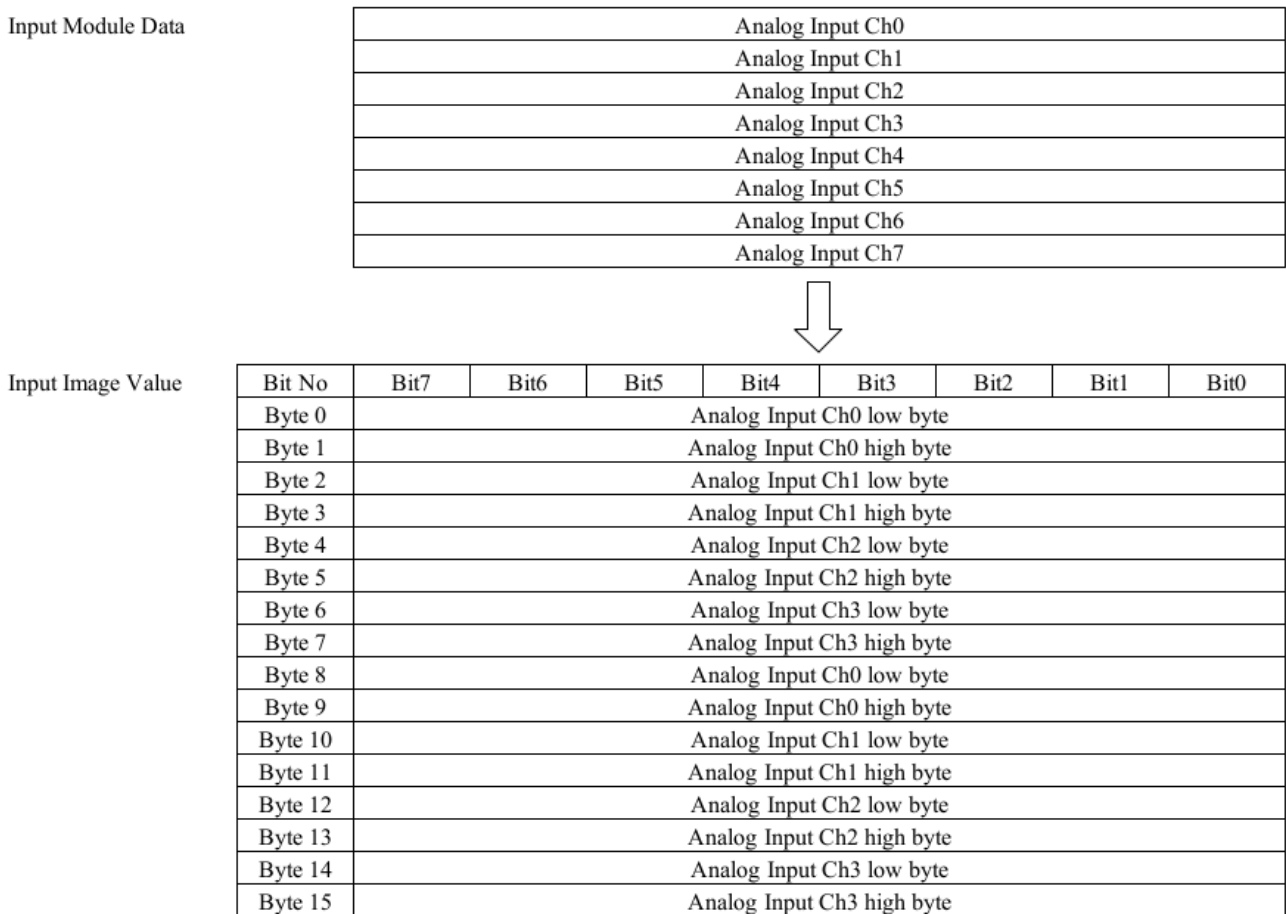



### 4.1.4. Analog Output Module

- . 4 Channel Analog Output Module

Output Image Value	Bit No	Bit7	Bit6	Bit5	Bit4	Bit3	Bit2	Bit1	Bit0
Byte 0	Analog Output Ch0 low byte								
Byte 1	Analog Output Ch0 high byte								
Byte 2	Analog Output Ch1 low byte								
Byte 3	Analog Output Ch1 high byte								
Byte 4	Analog Output Ch2 low byte								
Byte 5	Analog Output Ch2 high byte								
Byte 6	Analog Output Ch3 low byte								
Byte 7	Analog Output Ch3 high byte								



Output Module Data	Analog Output Ch0
	Analog Output Ch1
	Analog Output Ch2
	Analog Output Ch3

- . 8 Channel Analog Output Module

Output Image Value	Bit No	Bit7	Bit6	Bit5	Bit4	Bit3	Bit2	Bit1	Bit0
Byte 0	Analog Output Ch0 low byte								
Byte 1	Analog Output Ch0 high byte								
Byte 2	Analog Output Ch1 low byte								
Byte 3	Analog Output Ch1 high byte								
Byte 4	Analog Output Ch2 low byte								
Byte 5	Analog Output Ch2 high byte								
Byte 6	Analog Output Ch3 low byte								
Byte 7	Analog Output Ch3 high byte								
Byte 8	Analog Output Ch4 low byte								
Byte 9	Analog Output Ch4 high byte								
Byte 10	Analog Output Ch5 low byte								
Byte 11	Analog Output Ch5 high byte								
Byte 12	Analog Output Ch6 low byte								
Byte 13	Analog Output Ch6 high byte								
Byte 14	Analog Output Ch7 low byte								
Byte 15	Analog Output Ch7 high byte								



Output Module Data	Analog Output Ch0
	Analog Output Ch1
	Analog Output Ch2
	Analog Output Ch3
	Analog Output Ch4
	Analog Output Ch5
	Analog Output Ch6
	Analog Output Ch7

## 4.2. Example of Input Process Image (Input Register) Map

Input image data depends on slot position and expansion slot data type. Input process image data is only ordered by expansion slot position.

- For example slot configuration

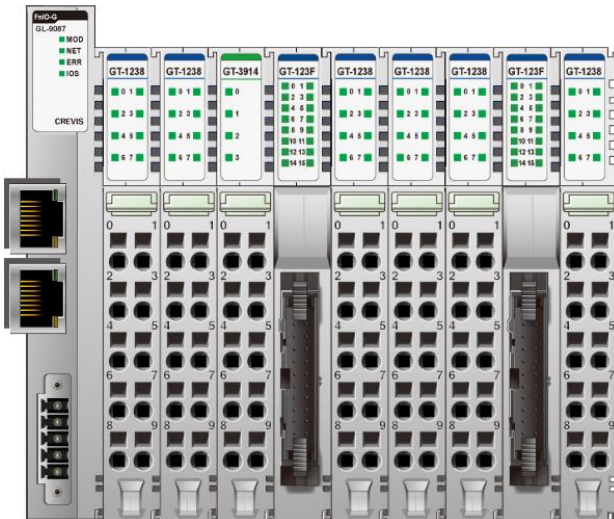

Slot Address	Module Description
#0	PROFINET Adapter
#1	8-discrete input
#2	8-discrete input
#3	4-analog input
#4	16-discrete input
#5	8-discrete input
#6	8-discrete input
#7	8-discrete input
#8	16-discrete input
#9	8-discrete input

- Input Process Image

Address	b15	b14	b13	b12	b11	b10	b9	b8	b7	b6	b5	b4	b3	b2	b1	b0
0x0001	Discrete Input 8 pts (Slot#2)							Discrete Input 8 pts (Slot#1)								
0x0002	Analog Input Ch0 high byte (Slot#3)							Analog Input Ch0 Low byte (Slot#3)								
0x0003	Analog Input Ch1 high byte (Slot#3)							Analog Input Ch1 Low byte (Slot#3)								
0x0004	Analog Input Ch2 high byte (Slot#3)							Analog Input Ch2 Low byte (Slot#3)								
0x0005	Analog Input Ch3 high byte (Slot#3)							Analog Input Ch3 Low byte (Slot#3)								
0x0006	Discrete Input 8 pts (Slot#4)							Discrete Input 8 pts (Slot#4)								
0x0007	Discrete Input 8 pts (Slot#6)							Discrete Input 8 pts (Slot#5)								
0x0008	Discrete Input 8 pts (Slot#8)							Discrete Input 8 pts (Slot#7)								
0x0009	Discrete Input 8 pts (Slot#9)							Discrete Input 8 pts (Slot#8)								

### 4.3. Example of Output Process Image (Output Register) Map

Output image data depends on slot position and expansion slot data type. Output process image data is only ordered by expansion slot position.

• For example slot configuration

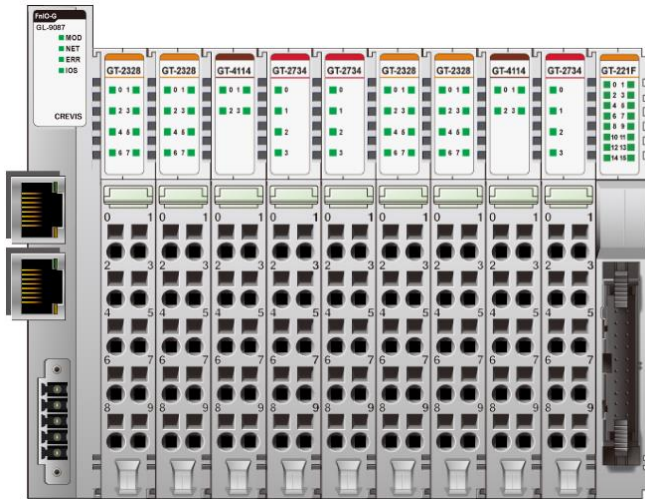

Slot Address	Module Description
#0	PROFINET Adapter
#1	8-discrete output
#2	8-discrete output
#3	4-analog output
#4	4-relay output
#5	4-relay output
#6	8-discrete output
#7	8-discrete output
#8	4-analog output
#9	4-relay output
#10	16-discrete output

• Output Process Image

Address	b15	b14	b13	b12	b11	b10	b9	b8	b7	b6	b5	b4	b3	b2	b1	b0
0x0800	Discrete Output 8 pts (Slot#2)								Discrete Output 8 pts (Slot#1)							
0x0801	Analog Output Ch0 high byte (Slot#3)								Analog Output Ch0 low byte (Slot#3)							
0x0802	Analog Output Ch1 high byte (Slot#3)								Analog Output Ch1 low byte (Slot#3)							
0x0803	Analog Output Ch2 high byte (Slot#3)								Analog Output Ch2 low byte (Slot#3)							
0x0804	Analog Output Ch3 high byte (Slot#3)								Analog Output Ch3 low byte (Slot#3)							
0x0805	Empty, Don't Care				Discrete Out 4 pts (Slot#5)				Empty, Don't Care				Discrete Out 4 pts (Slot#4)			
0x0806	Discrete Output low 8 pts (Slot#7)								Discrete Output low 8 pts (Slot#6)							
0x0807	Analog Output Ch0 high byte (Slot#8)								Analog Output Ch0 low byte (Slot#8)							
0x0808	Analog Output Ch1 high byte (Slot#8)								Analog Output Ch1 low byte (Slot#8)							
0x0809	Analog Output Ch2 high byte (Slot#8)								Analog Output Ch2 low byte (Slot#8)							
0x080A	Analog Output Ch3 high byte (Slot#8)								Analog Output Ch3 low byte (Slot#8)							
0x080B	Discrete Output low 8 pts (Slot#10)								Empty, Don't Care				Discrete Out 4 pts (Slot#9)			
0x080C	Empty, Don't Care								Discrete Output high 8 pts (Slot#10)							

## 5. Parameter

### 5.1. GL-9087 Parameter

Parameter	Setting	Description
Word data type	All type	Little Endian format(LSB-MSB)
Stop action	Clear output image to 0 *	All outputs are set to 0.
	Hold last valid output image	All outputs are remain the last value.
Stop action Mode	General Mode	For SIEMENS PLC
	Special Mode	For Soft PLC(ex-CoDeSys)

\* : Default setting

### 5.2. GL-9087 PROFINET IO Characteristics

#### 5.2.1. Device Identity

Item	Value
Vendor	CREVIS
Vendor ID	0x0140
Product family	CREVIS FnIO System
Device ID	0x9087
Details	GL9087 PROFINET IO Device

### 5.2.2. Device Access Point

Item	Value
Module Ident Number	0x00009087
Details	GL9087 PROFINET IO Device
Vendor Name	CREVIS
Order Number	GL-9087
Category	CREVIS PROFINET I/O
Software Version	V1.0
Hardware Version	V1.0
Maximal Input Length	1440 Bytes
Maximal Output Length	1440 Bytes
Physical Slots	0..32
Minimal Device Interval	4msec
Based on	portStack
DNS Compliant Name	GL9087-xx
Supports Extended Assignment of IP Address	No
Fixed in Slots	0
Instance Field of the Object UUID	1
Supports Multiple Write	Yes
Requires IOPS/IOCS	Yes
Requires Engineering tool which supports at least GSDML Version	V2.32

### 5.2.3. Sub-slot of GL-9087

Item	Value							
<b>Sub-slot Number</b>	<b>Sub-slot Label</b>							
32768 (0x8000)	X1							
32769 (0x8001)	P1							
<b>Sub-module</b>								
Sub-module Ident Number	0x00000001							
GL-9087 Parameters (Index : 1, Length : 2Bytes, Transfer sequence : 0)								
Byte Offset	Data							
0	0x00, 0x00							
Name of Parameter	Data Type	Byte Offset	Bit Offset	Bit Length	Default value	Value Range	Changeable	Visible
Word data format	Bit Area	0	0	1	MOTOROLA	0..1	Yes	Yes
Stop action	Bit Area	1	0	1	Clear output Images to 0	0..1	Yes	Yes
<b>Interface : GL-9087</b>								
Sub-module Ident Number	0x0002							
Sub-slot Number	32768 (0x8000)							
Supports Real time Class	Class 1							
Supports Isochronous Mode	No							
Number of Additional Input CRs	0							
Number of Additional Output CRs	0							
Number of Additional Multicast Provider CRs	0							
Number of Multicast Consumer CRs	0							
Supported Send-clock Factors (Base 31.25us)	32 64 128							
Supported Reduction Ratios	1 2 4 8 16 32 64 128 256 512							
<b>Port 1 : Port 1</b>								
Sub-module Ident Number	0x0003							
Sub-slot Number	32769 (0x8001)							
MAU Type	100BASETXFD							

## 6. Dimension

### 6.1. GL-9087

( mm)

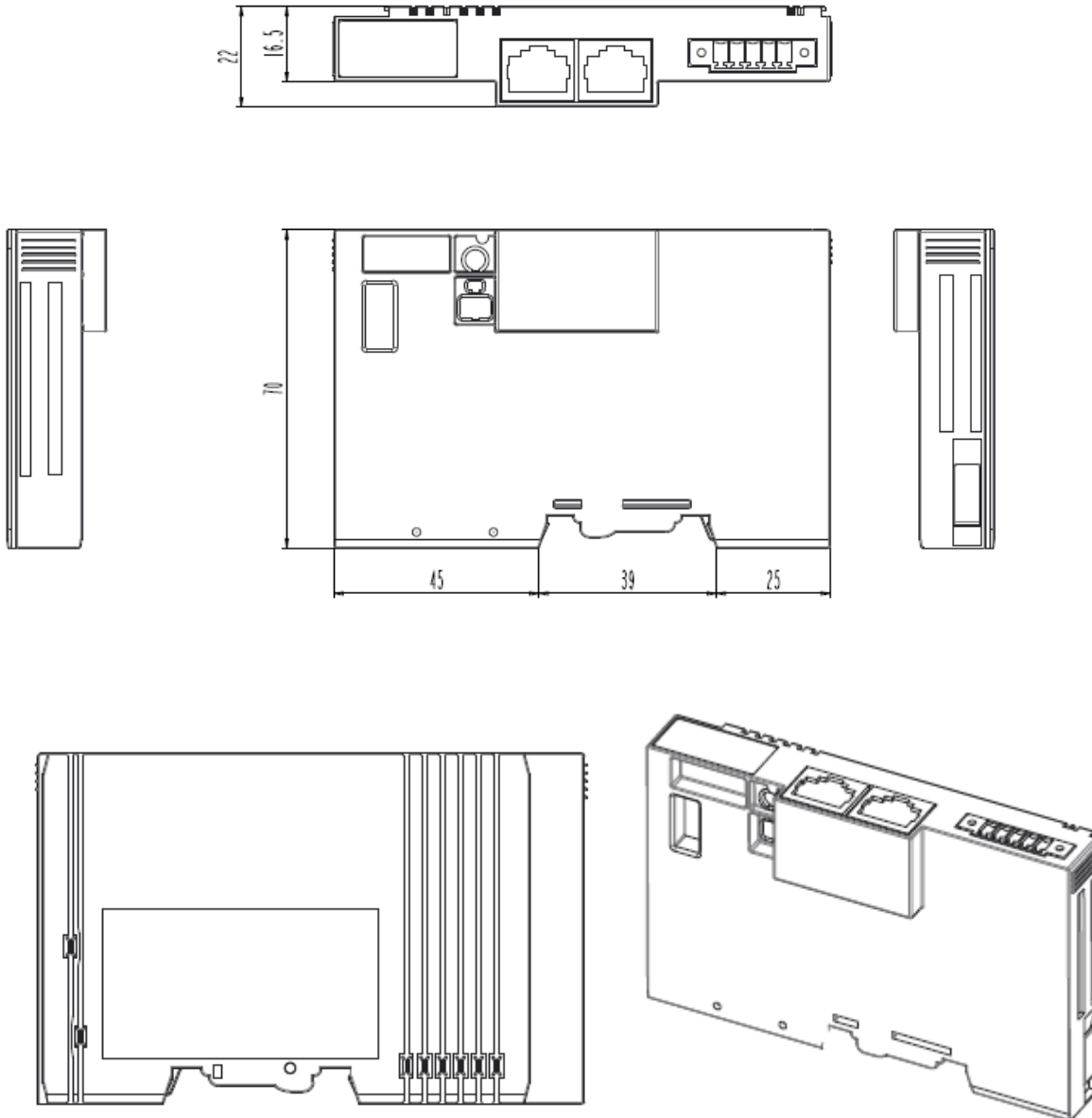

## 7. Mechanical Set Up

### 7.1. Total Expansion

The number of the module assembly that can be connected is 10. So the maximum length is 426mm Exception.

### 7.2. Plugging and Removal of the Components.

<p><b>DANGER</b></p> 	<p>Before work is done on the components, the voltage supply must be turned off.</p>
--	--



As above figure in order to safeguard the FnIO module from jamming, it should be fixed onto the DIN rail with locking level. To do so, fold on the upper of the locking lever.

To pull out the FnIO module, unfold the locking lever as below figure.





### 7.3. Internal G-Bus/Field Power Contacts

Communication between the NA series and the expansion module as well as system / field power supply of the bus modules is carried out via the internal bus. It is comprised of 6 data pin and 2 field power pin.

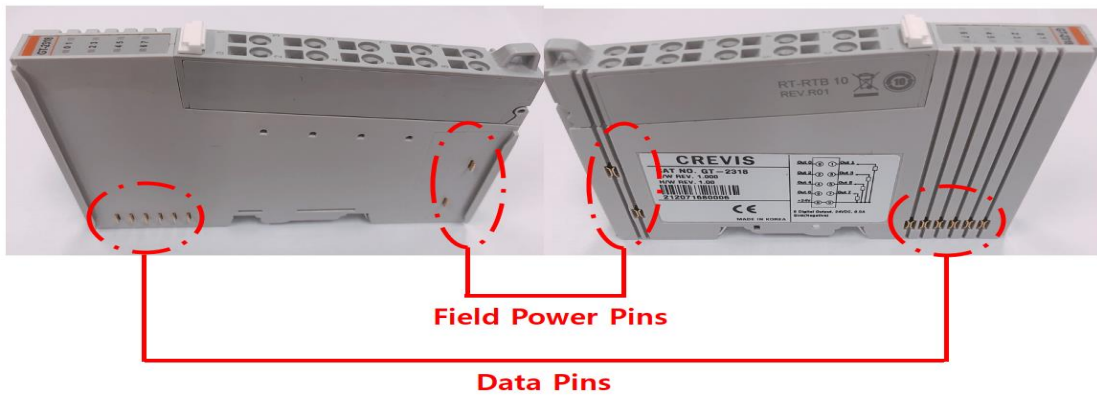

<p><b>DANGER</b></p> 	<p>Do not touch data and field power pins in order to avoid soiling and damage by ESD noise.</p>
--	--

## 8. Trouble Shooting

### 8.1. How to diagnose by LED indicator

LED Status	Cause	Action
All LED turns off	- No power	- Check main power Cable
MOD LED is red	- Occurrence critical error in firmware	- Contact Sales team and send module for repair.
ERR LED Blanking red	-Invalid Configuration	-Check I/O size configuration
IOS LED turns off	- Device may not be powered.	- Check main power Cable
IOS LED flashes red	- Adapter has no expansion module	- Add one or more expansion modules.
IOS LED is red	One or more expansion module occurred in fault state. - Detected invalid expansion module ID. - Overflowed Input/Output Size - Too many expansion module - Initialization failure - Communication failure. - Changed expansion module configuration. - Mismatch vendor code between adapter and expansion module.	- Use expansion slot up to 10. - Compose that IO total size is not excess. - Check status of expansion IO connection. - Check the vendor code of module.

## How to diagnose when device couldn't communicate network

### Inspection of wrong or omission cable connection.

- Check status of cable connection for each node.
- Check that all color matches between connector and cable.
- Check wire omission.

### Terminator resistor

- If terminator resistor is not installed, install terminator resistor
- Check location of terminator resistor

### Configuration of Node address

- Check duplication node address.

### Configuration of Master

- Check configuration of master
- Check whether to do download or don't
- Check composition is right
  - Configuration of communication baud rate
  - I/O size
  - Configuration of each nodes

### Ground and environment

- Check ground is contacted
- Check environment factor(temperature, humidity, etc) is in less than regular limit

## APPENDIX A

### A.1 Product List

No.	GT-Number	Description	ID(hex)
<b>Digital Input Module</b>			
	GT-1238	8 Points, Universal, 24Vdc, 10RTB	1238
	GT-123F	16 Points, Universal, 24Vdc, 20P connector	123F
	GT-12DF	16 Points, Universal, 24Vdc, 18RTB	12DF
	GT-12FA	32 Points, Universal, 24Vdc, 40P connector	12FA
	GT-1428	8 Points Input(Sink) / 8 Points Output(Source), 24Vdc/0.5A, 18RTB	1428
	GT-1804	4 Points, 120Vac, 10RTB	1804
	GT-1904	4 Points, 240Vac, 10RTB	1904
<b>Digital Output Module</b>			
	GT-2318	8 Points, Sink, 24Vdc/0.5A, 10RTB	2318
	GT-2328	8 Points, Source, 24Vdc/0.5A, 10RTB	2328
	GT-221F	16 Points, Sink, 24Vdc/0.3A, 20P connector	221F
	GT-222F	16 Points, Source, 24Vdc/0.3A, 20P connector	222F
	GT-225F	16 Points, Sink, 24Vdc/0.3A, 18RTB	225F
	GT-226F	16 Points, Source, 24Vdc/0.3A, 18RTB	226F
	GT-22BA	32 Points, Sink, 24Vdc/0.3A, 40P connector	22BA
	GT-22CA	32 Points, Source, 24Vdc/0.3A, 40P connector	22CA
	GT-2418	8 Points, Sink, Diagnostic, 24vdc/0.5A, 18RTB	2418
	GT-2428	8 Points, Source, Diagnostic, 24vdc/0.5A, 18RTB	2428
	GT-2618	8 Points, Sink, 24Vdc/2A, 10RTB	2618
	GT-2628	8 Points, Source, 24Vdc/2A, 10RTB	2628
	GT-2734	4 Points, MOS Relay, 240Vdc/ac, 0.5A, 10RTB	2734
	GT-2738	8 Ponits, MOS Relay, 240Vdc/ac, 0.5A, 18RTB	2738
	GT-2744	4 Points, Relay, 24Vdc/2A, 240Vac/2A, 10RTB	2744
	GT-2764	4 Points, MOS Relay, 24Vdc/ac, 2A, 10RTB	2764
	GT-2768	8 Points, MOS Relay, 24Vdc/ac, 2A, 18RTB	2768
	GT-2784	4 Points, MOS Relay, 110Vdc/ac, 1A, 10RTB	2784
	GT-2788	8 Points, MOS Relay, 110Vdc/ac, 1A, 18RTB	2788
<b>Analog Input Module</b>			
	GT-3002	LoadCell (TBD)	3002
	GT-3114	4 Channels, 0~20, 4~20mA, 12bits, 10RTB	3114
	GT-3154	4 Channels, 0~20, 4~20mA, 16bits, 10RTB	3154
	GT-3118	8 Channels, 0~20, 4~20mA, 12bits, 10RTB	3118
	GT-3158	8 Channels, 0~20, 4~20mA, 16bits, 10RTB	3158
	GT-311F	16 Channels, 0~20, 4~20mA, 12bits, 20P connector	311F
	GT-315F	16 Channels, 0~20, 4~20mA, 16bits, 20P connector	315F
	GT-317F	16 Channels, 0~20, 4~20mA, 12bits, 18RTB	317F
	GT-319F	16 Channels, 0~20, 4~20mA, 16bits, 18RTB	319F
	GT-3424	4 Channels, 0~10, 0~5, 1~5Vdc, 12bits, 10RTB	3424
	GT-3464	4 Channels, 0~10, 0~5, 1~5Vdc, 16bits, 10RTB	3464

	GT-3428	8 Channels, 0~10, 0~5, 1~5Vdc, 12bits, 10RTB	3428
	GT-3468	8 Channels, 0~10, 0~5, 1~5Vdc, 16bits, 10RTB	3468
	GT-342F	16 Channels, 0~10, 0~5, 1~5Vdc, 12bits, 20P connector	342F
	GT-346F	16 Channels, 0~10, 0~5, 1~5Vdc, 16bits, 20P connector	346F
	GT-347F	16 Channels, 0~10, 0~5, 1~5Vdc, 12bits, 18RTB	347F
	GT-349F	16 Channels, 0~10, 0~5, 1~5Vdc, 16bits, 18RTB	349F
	GT-3704	4 Channels, RTD, 10RTB	3704
	GT-3708	8 Channels, RTD, 20P connector	3708
	GT-3804	4 Channels, Thermocouple, 10RTB	3804
	GT-3808	8 Channels, Thermocouple, 20P connector	3808
	GT-3901	AC Measurement	3901
	GT-3914	4 Channels, Differential, 0~20, 4~20, +/-20mA, 12Bits, 10RTB	3914
	GT-3934	4 Channels, Differential, 0~20, 4~20, +/-20mA, 16Bits, 10RTB	3934
	GT-3918	8 Channels, Differential, 0~20, 4~20, +/-20mA, 12Bits, 18RTB	3918
	GT-3938	8 Channels, Differential, 0~20, 4~20, +/-20mA, 16Bits, 18RTB	3938
	GT-3924	4 Channels, Differential, 0~5, 0~10, +/-5, +/-10Vdc, 12Bits, 10RTB	3924
	GT-3944	4 Channels, Differential, 0~5, 0~10, +/-5, +/-10Vdc, 16Bits, 10RTB	3944
	GT-3928	8 Channels, Differential, 0~5, 0~10, +/-5, +/-10Vdc, 12Bits, 18RTB	3928
	GT-3948	8 Channels, Differential, 0~5, 0~10, +/-5, +/-10Vdc, 16Bits, 18RTB	3948
<b>Analog Output Module</b>			
	GT-4114	4CH, 0~20mA, 12Bits, 10RTB	4114
	GT-4154	4CH, 0~20mA, 16Bits, 10RTB	4154
	GT-4118	8CH, 0~20mA, 12Bits, 10RTB	4118
	GT-4158	8CH, 0~20mA, 16Bits, 10RTB	4158
	GT-4214	4CH, 4~20mA, 12Bits, 10RTB	4214
	GT-4254	4CH, 4~20mA, 16Bits, 10RTB	4254
	GT-4218	8CH, 4~20mA, 12Bits, 10RTB	4218
	GT-4258	8CH, 4~20mA, 16Bits, 10RTB	4258
	GT-4424	4CH, 0~10Vdc, 12Bits, 10RTB	4424
	GT-4464	4CH, 0~10Vdc, 16Bits, 10RTB	4464
	GT-4428	8CH, 0~10Vdc, 12Bits, 10RTB	4428
	GT-4468	8CH, 0~10Vdc, 16Bits, 10RTB	4468
	GT-442F	16CH, 0~10Vdc, 12Bits, 20P Connector	442F
	GT-446F	6CH, 0~10Vdc, 16Bits, 20P Connector	446F
	GT-447F	16CH, 0~10Vdc, 12Bits, 18RTB	447F
	GT-449F	16CH, 0~10Vdc, 16Bits, 18RTB	449F
	GT-4524	4CH, -10~10Vdc, 12Bits, 10RTB	4524
	GT-4564	4CH, -10~10Vdc, 16Bits, 10RTB	4564
<b>Special Module</b>			
	GT-5102	2CH, Encoder, Input, 5Vdc, 10RTB	5102
	GT-5112	2CH, Encoder, Input, 24Vdc, 10RTB	5112
	GT-5114	4CH, Encoder, Input, 24Vdc, 10RTB	5114
	GT-5211	1CH, RS 232, RTS/CTS, Full Duplex Type, 10RTB	5211
	GT-5212	2CH, RS 232, Full Duplex Type, 10RTB	5212
	GT-5221	1CH, RS 485, Full Duplex Type, 10RTB	5221

	GT-5231	1CH, RS 485, Half Full Duplex Type, 10RTB	5231
	GT-5232	2CH, RS 485, Half Full Duplex Type, 10RTB	5232
	GT-5352	2CH, Synchronous Serial Interface Input, 10RTB	5352
	GT-5442	2CH, PWM, Source, 0.5A/24Vdc, 18RTB	5442
	GT-5444	4CH, PWM, Source, 0.5A/24Vdc, 18RTB	5444
	GT-5521	1CH, Stepper Module (TBD)	5521
	GT-5642	2CH, Pulse Output, Source, 0.5A/24Vdc, 18RTB	5642
	GT-5652	2CH, Pulse Output, Differential, RS422, 18RTB	5652
<b>Power Module</b>			
	GT-7408	Shield Module	7408
	GT-7508	Common for 0Vdc	7508
	GT-7511	Power Expansion, In 24Vdc, Out 1A/5Vdc	7511
	GT-7518	Common for 24Vdc	7518
	GT-7588	Common for 0Vdc, 24Vdc	7588
	GT-7641	Field Power, 5/24/48 Vdc, 110/220 Vac	7641
	GT-7151	Noise Filter Module, None ID Type, 18RTB	7151
	GT-7851	Noise Filter Module, ID Type, 18RTB	7851

## A.2. Glossary

- System Power : The power for starting up CPU.
- Field Power : The power for input and output line.
  - Terminator Resistor : Resistor for prevention reflected wave.
- EDS : Electronic Data Sheet.
  - Sink : The method of in/output power supply if a device has no power source.
  - Source : The method of in/output power supply if a device has the power source.